

Instructions

BASIC SYSTEM

Being Safe at Home Survival Kit



**SafeFamilyLife**

www.SafeFamilyLife.com

2 oz. Pepper Spray with Wall Mount



This 2oz Oleoresin Capsicum pepper spray is great to keep near any entryway of your apartment. It even comes with a wall mount so that is easily and readily accessible.

Pepper spray has serious effects. It causes pain, inflammation of the eyes, nose and upper respiratory system. It will induce coughing, choking and nausea, as well as dilating the eyes causing temporary blindness. The mucous membranes will swell, making it difficult to breathe, leaving your attacker helpless. Effects will last approximately 45 minutes.

To use this Pepper Spray:

1. Hold can in upright position.
2. Turn actuator to remove safety.
3. Turn actuator to remove safety.
4. Point can at attackers face and firmly press the actuator.
5. After spraying the attacker, immediately run for help.

You will get approximately 8-10 one-second sprays with an effective range of ten to fifteen feet.

Avoid accidental contact with eyes, skin or mucous membranes. If contact is made, flush the affected area with cool water. Do not rub your skin and DO NOT use any creams, salves or soap. After you rinse the skin, move to an area with fresh air. The effects will generally disappear after 45 minutes but call your doctor if the symptoms persist.

The contents are under pressure so DO NOT puncture or incinerate the can. Also, do not store above 120 degrees Fahrenheit.

AutoDialer Security & Safety Alarm



Important Safety Tips

1. Do not install the system where it will be exposed to direct sunlight or rain.
2. The system siren is very loud, never put the unit close to your ear.
3. The unit should be away from heat sources such as radiators, heating ducts and stoves.
4. If the system sounds at random, it is possible that the location too close to a heat source, changing the location or direction of the unit can remedy this.
5. The system can provide valuable protection for your home and property if utilized properly.

Features:

- Motion Sensor, detects motion activates auto-dialer and alarm
- 14 Digit large number display with date/time
- Programmable security code, entry delay timing
- 5 emergency telephone numbers (up to 32 digits each)
- Programmable auto dialing cycle
- 5 Trigger recorder for alarm mode
- PAUSE key
- PANIC key
- PROG key
- Built-in flash memory to protect system data for power failure
- Battery Low indicator
- Tone dialing only
- Chime ON/OFF switch
- Built-in 105 dB alarm (with programmable alarm on/off)
- Adjustable sensor head
- External extend trigger input terminal (compatible magnetic sensor. PIR slave unit. Water alarm).
- External siren terminal (compatible outdoor siren)
- AC adaptor operated (included) with 9V battery back-up (not included)
- Wall mountable

Installation

1. Remove the screw of main unit from battery compartment cover, install one alkaline 9V battery, this is a back-up battery, in case of AC power failure.
2. Connect your existing telephone line cord between "LINE" jack on the AutoDialer the telephone wall jack in your house.
3. Connect the included line cord with your AutoDialer (this is the line with the clear plugs at either end) between the TEL. jack on the AutoDialer, and the other end into your telephone. You now have a wire from the TEL socket on your auto-dialer to your telephone. You should now have a dial tone.
4. Plug the AC adaptor to the DC 9V socket on the auto-dialer
5. Choose a suitable location, 5- 6 feet above from floor, drill holes and install anchors

and screws

6. Place the unit over the screws and slide it down to secure in place.

Changing the Password

a. Enter the factory pre-set pass number, 0-0-0 then press PROG button once, PASSWORD will flash on the auto-dialer screen.

b. Press the ARM/DISARM button to confirm that you want to enter the PASSWORD option.

c. Enter your new pass number followed by the ARM/DISARM button to confirm the new number (you can choose up to 6 numbers in your pass number).

d. Press the PROG button seven times to exit set-up mode.

To Store Telephone Numbers

a. Enter the pass number followed by PROG button twice.

b. MEMORY will flash on the auto-dialer screen.

c. Press the ARM/DISARM button to confirm this is the option you want.

d. You are now ready to program in your 5 chosen telephone numbers.

e. Press the UP and DOWN buttons to select position 1 – 5 (one being the first number the AutoDialer will call then the 2nd, 3rd, 4th and 5th) then press ARM/DISARM to confirm the location for the first number.

f. Now enter the number that you want to store, followed by ARM/DISARM to confirm and store the number (maximum of 32 numbers, but only display last 14 digits).

g. Repeat the steps to set-up remaining four numbers, if you choose.

To Delete A Telephone Number In Memory

a. Enter the pass number followed by PROG button twice.

b. MEMORY will flash on the auto-dialer screen.

c. Press the ARM/DISARM button to confirm that this is the option you want.

d. Press the UP and DOWN buttons to select the number you want to delete.

e. Press the ARM/DISARM button to delete the number.

f. Press the ARM/DISARM button to confirm the correct number has been deleted.

g. Press the PROG button six times to exit the set-up mode.

To Program the Siren On/Off

The auto-dialer has been factory set with the siren ON.

To change this to OFF:

a. Enter the pass number followed by PROG button three times.

b. The "JOC" icon will flash on the auto-dialer screen.

c. Press ARM/DISARM to confirm that this is the option you want.

d. Using the UP and DOWN buttons select SOUND OFF.

e. Then press the ARM/DISARM button to confirm that the SIREN is now off.

e. Press the PROG button five times to exit the set-up mode.

To Program the Auto Dial Function On/Off

The auto-dialer has been factory set with the call option ON.

To change this to call option to OFF:

a. Enter the pass number followed by PROG button four times.

b. The telephone with X icon will flash on the auto-dialer screen.

c. Press the ARM/DISARM to confirm that this is the option you want.

d. Using the UP and DOWN buttons select call OFF followed by the ARM/DISARM

button to confirm call OFF.

e. Press the PROG button four times to exit the set-up mode.

To Program the Auto Dialing Cycle

The auto-dialer has been factory set for auto dialing 3 cycles. (When motion is detected the auto dialer will call all stored numbers 3 times) You can change this cycle from 1 - 5 dialing times.

a. Enter the pass number followed by PROG button five times.

b. CYCLE will now flash on the auto-dialer screen.

c. Press ARM/DISARM button to confirm

d. Using the UP and DOWN buttons to select 1 - 5 followed by the ARM/DISARM button to confirm the cycle (how many times the auto-dialer will call you if motion is detected)

e. Press the PROG button three times to exit set up mode.

To Program Entry Delay Time

The auto-dialer has been factory set for a 20 second delay time. You can change this to 0, 5, 10, 15, or 20 seconds:

a. Enter the pass number followed by PROG button six times.

b. ENTRY will now flash on the auto-dialer screen.

c. Press the ARM/DISARM button to confirm that this is the option you want.

d. Using the UP and DOWN buttons select the seconds 0, 5, 10, 15, or 20. Press ARM/DISARM to confirm the number of seconds you require for the entry delay time.

e. Press the PROG button twice to exit set-up mode.

Real Time Setting

a. Enter the pass number followed by PROG button seven times.

b. TIME will flash on the auto-dialer screen.

c. Press the ARM/DISARM button to confirm that this is the option you want. The date will show in the auto-dialer screen as three sets of numbers, year, month and date followed by the real time. The first set of numbers will flash confirming that these can now be changed.

d. Press the ARM/DISARM button on the flashing numbers and using the UP and DOWN buttons select the correct date followed by the ARM/DISARM button to confirm and store. You will now have the correct date and time.

e. Press the PROG button once to exit set-up mode.

In standby mode, press and hold the PROG button for more than two seconds, then key in the test telephone number memory location, the telephone number stored in memory will automatically be dialed.

After selecting a location for the unit, switch ON the chime button on the side of the AutoDialer, and wait 60 seconds and then walk in front of the unit. The AutoDialer will detect motion and the chime will sound. If you walk beyond the detection range the chime will not sound.

To test the detection range try various angles and adjust the sensor angle for best coverage. Switch OFF the chime after this test.

Operation

To Arm the System

a. Enter the pass number followed by the ARM/DISARM button

- b. Three short beeps will sound and the ARM icon will show on the AutoDialer screen.
- c. You can press and hold "ARM" button 2 seconds on remote unit to ARM main unit. (the remote control not included, option for S100R)
- d. There will be a further single beep after 60 seconds, the AutoDialer is now set at ARM and ready to detect movement.

NOTE: Please ensure that the CHIME switch is set at OFF on the side of the AutoDialer before setting to ARM.

Alarm

In ARM mode system will detect any movement in the protected area and will sound a SIREN for 30 seconds on and 30 seconds off, and will automatically dial the numbers stored, one by one, in the CYCLE you have chosen, (amount of times the numbers are dialed). You will hear the same siren when the call is answered you can then call the Police or make the necessary arrangements.

In ARM mode, if the AutoDialer is set at SIREN OFF, the numbers stored will be dialed silently, when the call is answered you will hear a siren and know that movement has been detected, enabling you to call the Police or make necessary arrangements.

REMEMBER the AutoDialer has called you silently, no indication whatsoever is given from the AutoDialer to suggest it is dialing you.

To Disarm the System

- a. Enter the pass number followed by the DISARM button.
- b. You will hear one beep and the ARM icon will disappear from the AutoDialer screen to confirm that the AutoDialer has been DISARMED.
- c. You can press and hold "DISARM" button 2 seconds on remote unit to DISARM main unit.

Door Chime On/Off

- a. Switch the CHIME button to ON, on the side of the AutoDialer.
- b. Wait for 60 Seconds, there will be one beep.
- c. When movement is detected in the protected area the 'DING DONG' chime will sound.
- d. Switch the CHIME button to OFF, on the side of the Auto-dialer to stop the 'DING DONG' from sounding.

NOTE: When the Auto-dialer is in ARM mode the CHIME will NOT sound.

Panic Button

- a. Press "PANIC" button on main unit or press and hold "PANIC" button 2 seconds on remote control, instantly the ALARM will sound for 30 seconds, and the AutoDialer will begin dialing the stored numbers.
- b. To stop the alarm and the stored numbers being dialed, press password then ARM/ DISARM button.
- c. Or press and hold "DISARM" button 2 seconds on remote unit to stop the alarm and auto dialer.

Pause

The "PAUSE" function can be stored as one digit in the telephone number memory for some PABX dialing operation and every one "PAUSE" in the memory dialing sequence will stop for 3.6 seconds.

For example, if you store telephone number

"7,7,7,5,3,5,5--226" to memory location 2, operation as follows:

- a. Press password (0-0-0), then press "PROG" button, the system will into setup mode,
- b. Press PROG button to select function menu "MEMORY" icon flash.
- c. Press "ARM/DISARM" button to confirm.
- d. The system will get into first telephone number setting and LCD display.
- e. Press "* /UP" or "# /DOWN" to select memory location 2.
- f. Press "7,7,7,5,3,5,5" , Pause "2,2,6".
- g. Press "ARM/DISARM" button to confirm and the LCD will return display setup menu.

TROUBLE SHOOTING GUIDE

1. UNIT WILL NOT ARM/DISARM

- a. make sure you've entered the correct password, if not, reenter the password.
- b. If still doesn't work. Remove the 9V battery and adaptor plug, wait for 3 minutes, replace them again. Then try "ARM" & "DISARM" again.
- c. If it still doesn't work, press and hold down the PROG button, for up to 2 seconds, after a beep press PAUSE button, remove the 9V battery and adaptor plug for 3 minutes, replace them again, then reset-up and try to ARM/DISARM again.

2. UNIT WILL NOT DIAL

- a. Make sure the telephone connection is good.
- b. Make sure the telephone number is stored
- c. Make sure the system is setup in Autodial mode.

Mini Alert Motion Detector



The Mini Alert is a motion detection alarm that creates a triangle of protection that is impossible to penetrate without setting off the alarm. It requires no wiring and can be easily moved to any location.

1. Remove the battery cover on the back of the alarm by sliding it down. Insert the three included AA batteries according to the polarity marks in the battery compartment and replace the cover.

2. Choose a location for the alarm and mount the adjustable wall bracket using the screws and anchors provided.

3. Slide the alarm onto the wall bracket and angle the alarm in the direction of your choice.

4. Turn switch upward to use in Chime mode and downward to use the Alarm. There is a 30 second delay when using in Alarm mode.

Diversion Safe – Peanut Butter



This is a jar of peanut butter with a safe built inside, where you can hide valuables.

It looks just like the real thing and is even weight to fill full.

1. Unscrew the lid of jar.
2. Store your valuables in the safe.
4. Replace the lid of the jar.
5. Store for safe hiding.

Magnetic Door/Window Alarm



The **Magnetic Door/ Window Alarm** uses magnetic affinity to activate its 110 dB siren. The base of the alarm is attached to a door or window frame, the actuator is attached to the window or door. When the door or window is opened, the alarm and actuator separate causing the alarm to go off. Great for any door or window, particularly those hard to protect sliding glass doors. Requires 3 lithium button cell batteries (included and installed).

1. Attach the adhesive strips to the back of the actuator and alarm itself (the large piece goes on the alarm and the small piece on the actuator).
2. Attach the base of the alarm to the door or window frame.
3. Attach the actuator to the door or window, directly across from the alarm.

Door Stop Alarm



Use this 125db Door Stop Alarm as an entry alarm and to block a door from being opened. If anyone tries to open the door, this alarm will sound. There is also a movement sensor with adjustable sensitivity that will activate the alarm if it's tampered with.

1. Using a small Phillips head screwdriver, remove the battery cover from the bottom of the alarm. Insert one 9 volt battery, which is included. Replace the battery cover.

2. Turn the door alarm to the ON position.

3. Place the door alarm on the floor perpendicular to the door, just as you would a door stop.

4. If the door is opened it will strike the metal plate, preventing the door from opening and activating the alarm.

5. Alarm stops when pressure is released from door stop plate. Pull the metal door stop plate up until the alarm stops.

Glass Breakage Alarm



1. Remove the battery cover on the back of the alarm, by sliding it downward.
2. Insert the included 12 volt battery according to the polarity marks in the battery compartment and replace the cover.
3. Remove the protective backing from the adhesive located on the back of the alarm.
4. Attach the alarm to a glass window or door.
5. Turn the switch on the side to the ON position.

When the glass is hit, knocked or broke by anyone, the siren will sound for approximately 30 seconds and then shut off and reset.

The glass alarm can also be used as a personal property alarm to protect computers, TVs, stereo's, cabinets, etc.

UFO Alarm

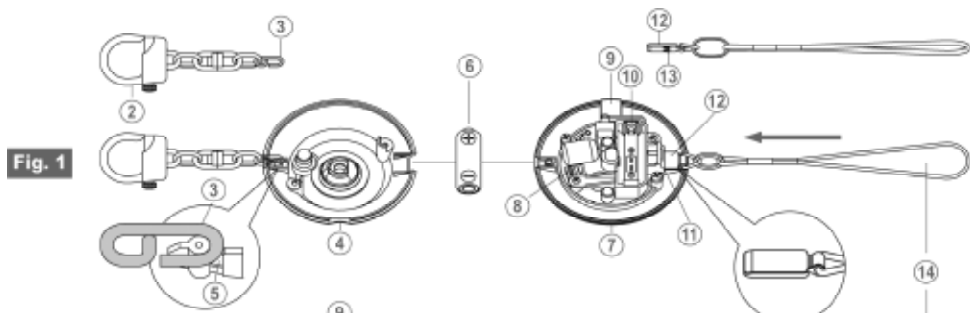

Fig. 1

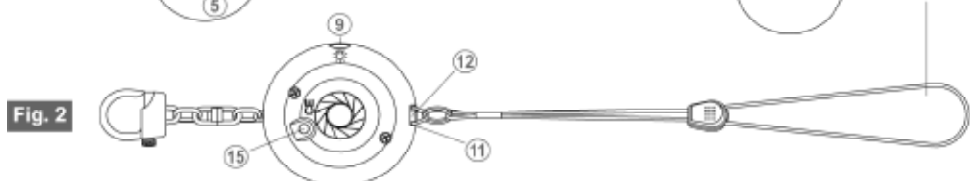

Fig. 2

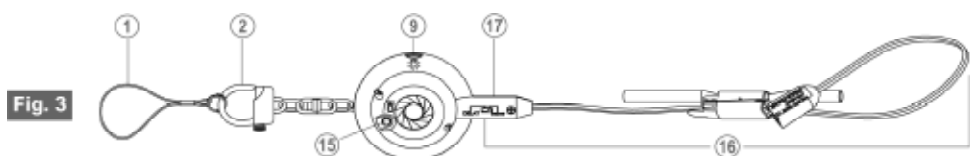

Fig. 3

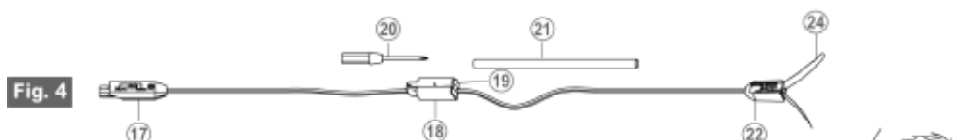

Fig. 4

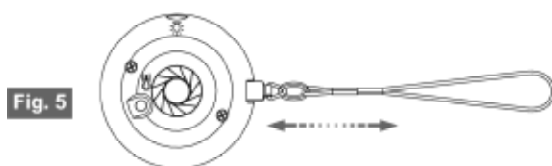

Fig. 5

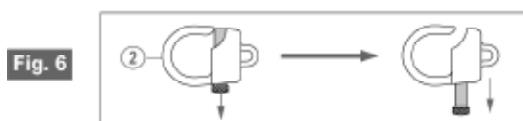

Fig. 6

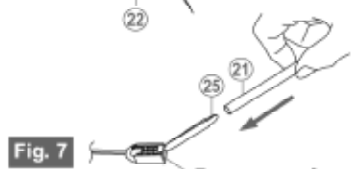

Fig. 7

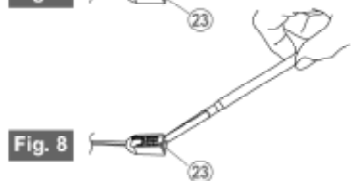

Fig. 8

- | | | | | |
|-------------------|----------------------|-------------------|----------------------|------------------------|
| ① Door knob strap | ⑥ Battery | ⑪ Plug socket | ⑯ Burglar alarm kit | ⑳ Soft sleeve |
| ② Snap hook | ⑦ Top cover | ⑫ Insulation plug | ⑰ Burglar alarm plug | ㉑ Plastic handle |
| ③ Connecting link | ⑧ Alarm test button | ⑬ Raised notch | ⑱ Retaining holder | ㉒ Opening end |
| ④ Bottom cover | ⑨ Handy light button | ⑭ Loop strap | ⑲ Retaining socket | ㉓ Open spring blades |
| ⑤ Recessed notch | ⑩ Battery holder | ⑮ Panic button | ㉔ Screwdriver | ㉕ Closed spring blades |

Product Assembly Guidelines



1. Use the screwdriver to unscrew and open the bottom cover, insert the insulation plug (the side with a red line must be facing up and the opposite side with the two raised notches must be facing down) into the plug socket on the top cover before installing the battery, otherwise the alarm will be immediately triggered. Insertion of the insulation plug is directional (one side with a red line and the other with two raised notches), ensure that it is inserted correctly.

NOTE: Do not insert the burglar alarm plug into the plug socket, otherwise the bottom cover and top cover cannot be disassembled or reassembled.

2. Install the battery into the battery holder (Make sure the polarity is correct).

3. Test the basic functions:

(1.) Alarm Siren:

Test 1: Press the red button (The alarm and light will be activated at the same time).

Test 2: Remove the insulation plug from the plug socket and reinsert it.

(2.) Flashlight: Press button.

4. Place the connecting link of the snap hook into the recessed notch inside the bottom cover.

5. Once reassembled and the alarm device is upside down, the side marked with a red line of the insulation plug should be facing up.

Note: The insulation plug can be pulled completely out of the plug socket by tugging on the loop strap and can be reinserted by pushing it back in.

Personal Alarm

If you feel threatened, press the panic button or pull the insulation plug, on the bottom of the alarm, out of the plug socket to instantly activate the high decibel siren and strobe light.

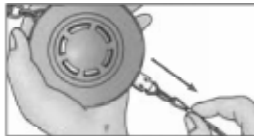

Anti-Snatch Alarm

1. When going out, attach the snap hook to the handle of your handbag and hold the loop strap or slip it around your wrist.



2. If your bag is snatched while you are holding on to it, the insulation plug will be pulled out of the plug socket (or you can also pull on the loop strap) to instantly activate the alarm siren and strobe light.

Burglar Alarm

1. Replace the insulation plug with the burglar alarm kit by using the burglar alarm plug.
2. When the burglar alarm kit v-shaped spring blades open, the alarm siren and strobe light will activate immediately. And when you close the v-shaped spring blades with your fingers, the alarm siren and strobe light stops immediately.

NOTE: When the burglar alarm kit is not in use, insert the closed v-shaped spring blades into the retaining socket of the retaining hold for storage (The same for the soft sleeve).

3. Attach the door knob strap to the snap hook.
4. Select INSTANT or DELAY alarm mode on the burglar alarm plug.

INSTANT MODE: (switch flipped to the right for INSTANT)

When the door, window or drawer is opened, the alarm siren and strobe light will be activated instantly.

DELAY MODE: (switch flipped to the left for DELAY)

When the door, window or drawer is opened, the alarm delay procedure is as follows (for 80 seconds):

First 10 sec

Mute

Strobe On

20 sec

Siren On

Strobe On

5 sec

Mute

Strobe On

20 sec

Siren On

Strobe On

5 sec

Mute

Strobe On

20 sec

Siren On

Strobe On

End of Alarm Delay Cycle

Mute

Flashing Strobe Continues

NOTE: If you want to change the alarm mode (Instant/Delay) while the alarm is triggered, you need to close the v-shaped spring blades first and then flip the switch to the other alarm mode otherwise the current alarm mode will continue to be active.

Door or Window Alarm (Indoor Setup)

1. Hang the door knob strap (attached to the snap hook) around the door handle (for window alarm setup, an appropriate hook next to the window may be needed to hang the door knob strap or snap hook).
2. Insert the closed v-shaped spring blades into the gap between the door and its frame (or window and its frame) to complete the burglar alarm setup.
3. When the door/window is opened by an intruder, the v-shaped spring blades will open and instantly activate the alarm siren and strobe light.



Door Alarm Away Mode (Outdoor Setup)

1. Slip the door knob strap around the inside door handle. Insert the front tip of the closed spring blades into the soft sleeve.
2. Stand outside the door and hold the other end of the soft sleeve and make sure the opening end of the plastic handle is against the inside edge of the door frame.
3. Pull the door towards its frame with your other hand (the door is not completely closed yet), so that the closed v-shaped spring blades together with the soft sleeve are clipped between the door and its frame. Before completely closing the door from the outside, pull the soft sleeve out of the gap.
4. After the door is completely closed, the closed spring blades are clipped in between the door and its frame and the burglar setup is completed. If someone opens the door, the blades will separate and the alarm will instantly sound.

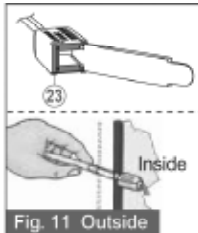
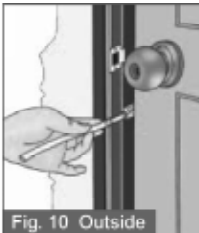



Drawer Alarm

Place the alarm inside and against the front panel of the drawer and follow the procedures in the instructions above (Function 2) to complete the burglar alarm setup.

Flashlight

1. Press button to turn on the flashlight flashlight
2. When using the light in the dark, you can easily find the button by feeling for the raised printing on the alarm.

Notes

- A. Please read the description below regarding specific scenarios where the Away Burglar Alarm may not be setup.
- Setting up the alarm from the outside is suitable for doors that open inwards and sliding doors only. Doors that open outwards are not suitable for this setup.
 - Doors and frames that have square edges and a smooth gap are suitable for inserting the closed v-shaped spring blades. If the door and frame has a particular design or dimension that doesn't allow the opening of the end of the plastic handle to be pulled firmly against it on the inside then it is not suitable for this setup.
 - Certain door frames that have decorative molding outlines or doors with grooved edges on the inside, may cause the plastic handle or the spring blades to be stuck in between the door and the frame and may not be suitable for setting up the Away Burglar Alarm.
- B. On the doors and frames that have a narrow gap, pull out the soft sleeve before the door is completely closed, otherwise the soft sleeve may get stuck in the gap.

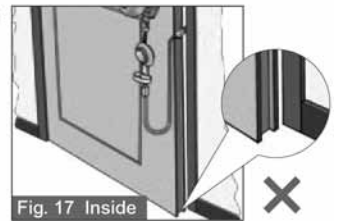
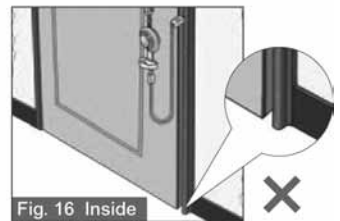
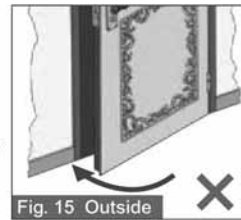

- C. On the doors or the front drawer panels that are slim, the front part of the closed v-shaped spring blades may protrude a bit after the alarm setup is complete. If so, push in the front tip of the spring blades
- D. The appropriate positions to insert the closed spring blades into the gap should not be higher than the door handle otherwise the hanging weight of the harness and alarm could pull it out.
- E. When the alarm volume becomes low, drags, not continuous or abnormal, replace the battery, even if the light still functions, because it consumes less power.
- F. When testing the alarm, block the six holes on the top cover with the palm of your hand or a piece of cloth to muffle the sound of the siren so to protect your hearing.
- G. Displaying the UFO Burglar Alarm sticker visibly outside can have a similar effect as having a "Beware of the Dog" sign.
- H. This device is not water-proof; do not get wet or submerge.

Limited One Year Warranty (Does not cover the battery or damage caused by the user)

